

**Essential GMAT® Quant Skills**

**Adding Fractions**

**Same Denominator**

$$\frac{a}{b} + \frac{c}{b} = \frac{a+c}{b}$$

**Different Denominators**

$$\frac{a}{b} + \frac{c}{d} = \frac{ad+bc}{bd}$$

**Example:**

$$\frac{2}{3} + \frac{5}{7} = \frac{14+15}{21}$$

**Subtracting Fractions**

**Same Denominator**

$$\frac{a}{b} - \frac{c}{b} = \frac{a-c}{b}$$

**Different Denominators**

$$\frac{a}{b} - \frac{c}{d} = \frac{ad-bc}{bd}$$

**Example:**

$$\frac{2}{3} - \frac{5}{7} = \frac{14-15}{21}$$

**The Distributive Property**

$$\frac{a+c}{b} = \frac{a}{b} + \frac{c}{b}$$

**Multiplying Fractions**

$$\frac{a}{b} \times \frac{d}{c} = \frac{ad}{bc}$$

**Example:**

$$\frac{2}{3} \times \frac{5}{7} = \frac{10}{21}$$

**Dividing Fractions**

$$\frac{a}{b} \div \frac{c}{d} = \frac{a}{b} \times \frac{d}{c} = \frac{ad}{bc}$$

**Example:**

$$\frac{2}{3} \div \frac{5}{7} = \frac{2}{3} \times \frac{7}{5} = \frac{14}{15}$$

**Reciprocals**

To get the reciprocal of a non-zero number, divide 1 by that number.

**Comparing Fraction Size: Bow Tie Method**

$$\frac{a}{b} > \frac{c}{d} \text{ if } ad > bc$$

**Example:**

$$\frac{3}{4} > \frac{5}{7} \text{ because } 21 > 20$$

**Converting a Fraction to a Percent**

To convert a fraction to a percent, convert the fraction to a decimal, multiply the decimal by 100 and attach the percent sign.

**Linear & Quadratic Equations**

**Factoring Out Common Factors**

**Example:**

- $ab + ac = d$
- $a(b + c) = d$

Since  $a$  is common to all of the terms on the left side of the equation, it can be factored out.

**Example:**

- $4x + 4y = 7$
- $4(x + y) = 7$

Since 4 is common to all of the terms on the left side of the equation, it can be factored out.

**Squares of Fractions**

$$\left(\frac{a}{b}\right)^2 = \frac{a^2}{b^2}$$

**Square Roots of Fractions**

$$\sqrt{\frac{x}{y}} = \frac{\sqrt{x}}{\sqrt{y}}$$

**Properties of a Number Between 0 and 1**

If  $0 < x < 1$ , it must be true that  $x^2 < x < \sqrt{x}$   
**The Zero Product Property**

If  $a \times b = 0$ , then one of the following is true:

- $a = 0$
- $b = 0$
- $a$  and  $b = 0$

**Expression Set Equal to Zero**

$x$  **can** equal 0

- $x(x + 100) = 0$
- $x = 0$  or  $x + 100 = 0$

**General Form of a Quadratic Equation**

$$ax^2 + bx + c = 0$$

Before a quadratic equation can be factored, it must be written in the general form.

**Factoring a Quadratic Equation**

$$x^2 + bx + c = 0 \text{ factors to: } (x + p)(x + q) = 0$$

- $p$  and  $q$  must multiply to  $c$
- $p$  and  $q$  must add to  $b$ .

**Example:**

$$x^2 - 3x - 28 = 0 \text{ factors to: } (x - 7)(x + 4) = 0$$

- $-7$  and  $4$  multiply to  $-28$
- $-7$  and  $4$  add to  $-3$

### FOILING Quadratic Equations

**Example:**

$$(x - 7)(x + 4) = 0$$

→ **Multiply the First terms:**

$$(x) \times (x) = x^2$$

→ **Multiply the Outside terms:**

$$(x) \times (+4) = +4x$$

→ **Multiply the Inside terms:**

$$(-7) \times (x) = -7x$$

→ **Multiply the Last terms:**

$$(-7) \times (+4) = -28$$

$$= x^2 - 3x - 28 = 0$$

### 3 Common Quadratic Identities

$$1. (x + y)^2 = (x + y)(x + y) = x^2 + 2xy + y^2$$

$$2. (x - y)^2 = (x - y)(x - y) = x^2 - 2xy + y^2$$

$$3. (x + y)(x - y) = x^2 - y^2$$

### Some Examples of a Difference of Squares

$$\Rightarrow x^2 - 9 = (x - 3)(x + 3)$$

$$\Rightarrow 4x^2 - 100 = (2x - 10)(2x + 10)$$

$$\Rightarrow x^2y^2 - 16 = (xy - 4)(xy + 4)$$

$$\Rightarrow 3^{30} - 2^{30} = (3^{15})^2 - (2^{15})^2 = (3^{15} + 2^{15})(3^{15} - 2^{15})$$

### PEMDAS: The Order of Mathematical Operations

Parentheses

Exponents

Multiplication and Division

Addition and Subtraction

### Properties of Numbers

#### Even/Odd Rules for Addition/Subtraction

- (odd) + (odd) = even
- (even) + (even) = even
- (even) + (odd) = odd
- (odd) - (odd) = even
- (even) - (even) = even

#### Multiplication Rules for Even and Odd Numbers

- even × even = even
- even × odd = even
- odd × even = even
- odd × odd = odd

#### Division Rules for Even and Odd Numbers

$\frac{\text{even}}{\text{odd}}$  is even

$\frac{\text{odd}}{\text{odd}}$  is odd

$\frac{\text{even}}{\text{even}}$  is even or odd

### Prime Numbers Less Than 100

2, 3, 5, 7, 11, 13, 17, 19, 23, 29, 31, 37, 41, 43, 47, 53, 59, 61, 67, 71, 73, 79, 83, 89, 97

#### Multiplication and Division of Numbers with the Same Sign

$$(+) (+) = (+) \quad (-) (-) = (+)$$

$$\frac{(+)}{(+)} = (+) \quad \frac{(-)}{(-)} = (+)$$

#### Multiplication and Division of Numbers with Different Signs

$$(+) (-) = (-) \quad \frac{(+)}{(-)} = (-)$$

### Factors

If y divides evenly into x, we say y is a factor of x.

**Example:**

What are the factors of 16?

- 1, 2, 4, 8, and 16

### Multiples

A multiple of a number is the product of that number and any integer.

**Example:**

What are the multiples of 4?

- 4, 8, 12, 16, 20, ..., 4n

### A Formula for Division

$$\frac{x}{y} = \text{Quotient} + \frac{\text{remainder}}{y}$$

**Example:**

$$\frac{23}{5} = 4 + \frac{3}{5}$$

### Divisibility Rules

#### Number Divisible by 2

A number is divisible by 2 if the ones digit is 0, 2, 4, 6, or 8

#### Number Divisible by 3

A number is divisible by 3 if the sum of all the digits is divisible by 3.

#### Number Divisible by 4

If the last two digits of a number are a number divisible by 4, then the number is divisible by 4.

#### Number Divisible by 5

A number is divisible by 5 if the last digit is a 0 or 5.

#### Number Divisible by 6

A number is divisible by 6 if the number is divisible by both 2 and 3.

#### Number Divisible by 8

If the last three digits of a number are a number divisible by 8, then the number is divisible by 8.

#### Number Divisible by 9

A number is divisible by 9 if the sum of all the digits is divisible by 9.

#### Number Divisible by 11:

A number is divisible by 11 if the sum of the odd-numbered place digits minus the sum of the even-numbered place digits is divisible by 11.

### The Range of Possible Remainders

A remainder must be a non-negative integer that is less than the divisor.

### Finding the Number of Factors in a Particular Number

**Step 1:** Find the *prime factorization* of the number.

**Step 2:** Add 1 to the value of each exponent. Then multiply these results and the product will be the total number of factors for that number.

**Example:**

The number of factors of 240

- $240 = 2^4 \times 3^1 \times 5^1$
- $(4 + 1) \times (1 + 1) \times (1 + 1) = 20$
- 240 has a total of 20 factors

### Finding the LCM

**Step 1:** Find the prime factorization of each integer. That is, prime factorize each integer and put the prime factors of each integer in exponent form.

**Step 2:** Of any *repeated* prime factors among the integers in the set, take *only* those with the *largest* exponent. For example, if we had  $3^2$  and  $3^3$ , we'd choose  $3^3$  and not  $3^2$ . If we're left with two of the same power (for example,  $3^2$  and  $3^2$ ), just take that number once.

**Step 3:** Of what is left, take *all non-repeated* prime factors of the integers.

**Step 4:** Multiply together what you found in Steps 2 and 3. The result is the least common multiple.

**Example:**

The LCM of 24 and 60

**Step 1:**

- $24 = 2^3 \times 3^1$
- $60 = 2^2 \times 3^1 \times 5^1$

**Step 2:**

- $2^3, 3^1$

**Step 3:**

- $5^1$

**Step 4:**

- $8 \times 3 \times 5 = 120$

### Finding the GCF

**Step 1:** Find the prime factorization of each number. That is, prime factorize each number and put the prime factors of each number in exponent form.

**Step 2:** Of any *repeated* prime factors among the numbers, take only those with the smallest exponent. (If *no repeated* prime factors are found, the GCF is 1.)

**Step 3:** Multiply together the numbers that you found in step 3; this product is the GCF.

**Example:**

The GCF of 24 and 60

**Step 1:**

- $24 = 2^3 \times 3^1$
- $60 = 2^2 \times 3^1 \times 5^1$

**Steps 2 and 3:**

- $2^2, 3^1$

**Step 4:**

- $4 \times 3 = 12$

### LCM × GCF

If the LCM of x and y is p and the GCF of x and y is q, then  $xy = pq$

### Any Factorial ≥ 5!

Any factorial ≥ 5! will always have zero as its units digit.

### Trailing Zeroes

The number of trailing zeros of a number is the number of (5 × 2) pairs in the prime factorization of that number.

**Examples:**

- ⇒ 520 can be expressed as  $52 \times 10 = 52 \times (5 \times 2)$  and thus has **one** trailing zero.
- ⇒ 5,200 can be expressed as  $52 \times 100 = 52 \times 10^2 = 52 \times (5 \times 2)^2$  and has **two** trailing zeros.

### Leading Zeroes in a Decimal

If X is an integer with k digits, then  $1/x$  will have  $k - 1$  leading zeros unless x is a perfect power of 10, in which case there will be  $k - 2$  leading zeroes.

### Terminating Decimals

The decimal equivalent of a fraction will terminate if and only if the denominator of the reduced fraction has a prime factorization that contains only 2s or 5s, or both.

**Examples:**

- $\frac{1}{20} = 0.05$
- $\frac{1}{12} = 0.083333333\dots$

### Patterns in Units Digits

**Number 0:**

All powers of 0 end in 0.

**Number 2:**

The units digits of positive powers of 2 will follow the four-number pattern 2-4-8-6.

**Number 3:**

The units digits of powers of 3 will follow the four-number pattern 3-9-7-1.

**Number 4:**

The units digits of powers of 4 follow a two-number pattern: 4-6. All positive odd powers of 4 end in 4, and all positive even powers of 4 end in 6.

**Number 5:**

All positive integer powers of 5 end in 5.

**Number 6:**

All positive integer powers of 6 end in 6.

**Number 7:**

The units digits of positive powers of 7 will follow the four-number pattern 7-9-3-1.

**Number 8:**

The units digits of positive powers of 8 will follow the four-number pattern 8-4-2-6.

**Number 9:**

The units digits of powers of 9 follow a two-number pattern: 9-1. All positive odd powers of 9 end in 9, and all positive even powers of 9 end in 1.

Perfect Squares

A perfect square, other than 0 and 1, is a number such that all of its prime factors have even exponents.

**Example:**

→  $144 = 2^4 \times 3^2$

Perfect Cubes

A perfect cube, other than 0 or 1, is a number such that all of its prime factors have exponents that are divisible by 3.

**Example:**

→  $27 = 3^3$

Two Consecutive Integers

Two consecutive integers will never share any prime factors. Thus, the GCF of two consecutive integers is 1.

**Roots & Exponents**

Perfect Squares to Memorize

0, 1, 4, 9, 16, 25, 36, 49, 64, 81, 100, 121, 144, 169, 196, and 225.

Perfect Cubes to Memorize

0, 1, 8, 27, 64, 125, 216, 343, 512, 729, and 1,000.

Non-perfect Square Roots to Memorize

$\sqrt{2} \approx 1.4, \sqrt{3} \approx 1.7, \sqrt{5} \approx 2.2$

Multiplying Radicals

$\sqrt[m]{a} \times \sqrt[m]{b} = \sqrt[m]{ab}$  and

$\sqrt[m]{ab} = \sqrt[m]{a} \times \sqrt[m]{b}$

**Example:**

$\sqrt{5} \times \sqrt{7} = \sqrt{5 \times 7} = \sqrt{35}$

Dividing Radicals

$\frac{\sqrt[n]{a}}{\sqrt[n]{b}} = \sqrt[n]{\frac{a}{b}}$  and  $\sqrt[n]{\frac{a}{b}} = \frac{\sqrt[n]{a}}{\sqrt[n]{b}}$

**Example:**

$\frac{\sqrt{54}}{\sqrt{6}} = \sqrt{\frac{54}{6}} = \sqrt{9} = 3$

Addition and Subtraction of Radicals

$\sqrt{a+b} \neq \sqrt{a} + \sqrt{b}$

**Example:**

$\sqrt{25+16} \neq 5+4$

$\sqrt{25+16} = \sqrt{41} \approx 6.40$

Taking the Square Root of a number and/or Binomial

$\sqrt{x^2} = |x|$  thus  $\sqrt{(x+y)^2} = |x+y|$

Exponents to Memorize

**Bases of 2**

$2^0 = 1$	$2^1 = 2$	$2^2 = 4$
$2^3 = 8$	$2^4 = 16$	$2^5 = 32$
$2^6 = 64$	$2^7 = 128$	$2^8 = 256$
$2^9 = 512$	$2^{10} = 1,024$	

**Bases of 3**

$3^1 = 3$	$3^2 = 9$	$3^3 = 27$
$3^4 = 81$	$3^5 = 243$	

**Bases of 4**

$4^1 = 4$	$4^2 = 16$	$4^3 = 64$
$4^4 = 256$		

**Bases of 5**

$5^1 = 5$	$5^2 = 25$	$5^3 = 125$
$5^4 = 625$		

Multiplication of Like Bases

$(x^a)(x^b) = x^{a+b}$

Division of Like Bases

$\frac{x^a}{x^b} = x^{a-b}$

Power to a Power Rule

$(x^a)^b = x^{ab}$

and

$(4^{10})^10 = 4^{100}$

Multiplication of Different Bases and Like Exponents

$(x^a)(y^a) = (xy)^a$

Division of Different Bases and Like Exponents

$\frac{x^a}{y^a} = \left(\frac{x}{y}\right)^a$

Radicals Can Be Expressed In Exponential Form

$\sqrt{x} = x^{\frac{1}{2}}, \sqrt[3]{x} = x^{\frac{1}{3}}$ , and in general for any positive number x,  $\sqrt[b]{x^a} = x^{\frac{a}{b}}$

**Example:**

$(\sqrt[3]{x})^2 = \sqrt[3]{x^2} = (x^2)^{\frac{1}{3}} = x^{\frac{2}{3}}$

Multiple Square Roots

$\sqrt[a]{\sqrt[b]{x}} = \left(x^{\frac{1}{b}}\right)^{\frac{1}{a}} = x^{\frac{1}{b} \times \frac{1}{a}} = x^{\frac{1}{ab}}$

**Example:**

$\Rightarrow \sqrt{3\sqrt{3\sqrt{3}}} = \sqrt{3} \times \sqrt{\sqrt{3}} \times \sqrt{\sqrt{\sqrt{3}}}$   
 $\Rightarrow 3^{\frac{1}{2}} \times 3^{\frac{1}{2} \times \frac{1}{2}} \times 3^{\frac{1}{2} \times \frac{1}{2} \times \frac{1}{2}} = 3^{\frac{1}{2}} \times 3^{\frac{1}{4}} \times 3^{\frac{1}{8}}$   
 $\Rightarrow 3^{\frac{1}{2} + \frac{1}{4} + \frac{1}{8}} = 3^{\frac{7}{8}}$

### Nonzero Base Raised to the Zero Power

When a nonzero base is raised to the zero power, the expression equals 1.

### Any Base Raised to the 1<sup>st</sup> Power

When a base is raised to the first power, the value of the expression is simply that base.

### Raising a Base to a Negative Exponent

$$x^{-1} = \frac{1}{x} \text{ and in general, } x^{-y} = \frac{1}{x^y}$$

**Examples:**

$$2^{-2} = \frac{1}{2^2} = \frac{1}{4} \qquad \frac{1}{3^3} = 3^{-3}$$

$$\left(\frac{3}{7}\right)^{-3} = \left(\frac{7}{3}\right)^3$$

### Addition and Subtraction of Like Bases

When adding or subtracting expressions with exponents, consider factoring out common factors.

**Example:**

$$\begin{aligned} \rightarrow 2^{10} + 2^{11} + 2^{12} \\ \rightarrow 2^{10}(1 + 2^1 + 2^2) = 2^{10}(7) \end{aligned}$$

### Addition and Subtraction of Like Radicals

**Example:**

$$\begin{aligned} \Rightarrow 10\sqrt[3]{5} + 5\sqrt[3]{5} + 6\sqrt[3]{5} + 2\sqrt[3]{5} + 2\sqrt[3]{5} \\ \Rightarrow \sqrt[3]{5}(10 + 5 + 6 + 2 + 2) \\ \Rightarrow \sqrt[3]{5}(25) = 5^{\frac{1}{3}} \times 5^2 = 5^{\frac{1}{3} + 2} = 5^{\frac{1}{3} + \frac{6}{3}} = 5^{\frac{7}{3}} \end{aligned}$$

### Special Addition Rule with Exponents

$$2^n + 2^n = 2^{n+1}$$

$$3^n + 3^n + 3^n = 3^{n+1}$$

$$4^n + 4^n + 4^n + 4^n = 4^{n+1}$$

The rule continues on forever with different bases.

### Number Properties of Exponents

**Case #1**

Base: greater than 1

Exponent: even positive integer

$$\Rightarrow \text{Result is larger } 5^2 > 5$$

**Case #2**

Base: greater than 1

Exponent: odd positive integer greater than 1

$$\Rightarrow \text{Result is larger } 5^3 > 5$$

**Case #3**

Base: less than -1

Exponent: even positive integer

$$\Rightarrow \text{Result is larger } (-5)^2 > (-5)$$

**Case #4**

Base: less than -1

Exponent: odd positive integer greater than 1

$$\Rightarrow \text{Result is smaller } (-5)^3 < -5$$

**Case #5**

Base: positive proper fraction

Exponent: even positive integer

$$\Rightarrow \text{Result is smaller } \left(\frac{1}{5}\right)^2 < \left(\frac{1}{5}\right)$$

**Case #6**

Base: negative proper fraction

Exponent: even positive integer

$$\Rightarrow \text{Result is larger } \left(-\frac{1}{5}\right)^2 > \left(-\frac{1}{5}\right)$$

**Case #7**

Base: positive proper fraction

Exponent: odd positive integer greater than 1

$$\Rightarrow \text{Result is smaller } \left(\frac{1}{5}\right)^3 < \left(\frac{1}{5}\right)$$

**Case #8**

Base: negative proper fraction

Exponent: odd positive integer greater than 1

$$\Rightarrow \text{Result is larger } \left(-\frac{1}{5}\right)^3 > \left(-\frac{1}{5}\right)$$

**Case #9**

Base: greater than 1

Exponent: positive proper fraction

$$\Rightarrow \text{Result is smaller } 5^{\frac{1}{2}} < 5$$

**Case #10**

Base: positive proper fraction

Exponent: positive proper fraction

$$\Rightarrow \text{Result is larger } \left(\frac{1}{5}\right)^{\frac{1}{2}} > \left(\frac{1}{5}\right)$$

### Square Roots of Large Perfect Squares

When a perfect square ends with an even number of zeros, the square root of such a perfect square will have exactly half of the number of zeros to the right of the final nonzero digit as the perfect square.

**Example:**

$$\sqrt{10,000} = 100$$

### Square Roots of Small Perfect Squares

If a decimal with a finite number of decimal places is a perfect square, its square root will have exactly half of the number of decimal places. Thus, a perfect square decimal must have an even number of decimal places.

**Example:**

$$\sqrt{0.0004} = \sqrt{\frac{4}{10,000}} = \frac{2}{100} = 0.02$$

### Cube Roots of Large Perfect Cubes

The cube root of a perfect cube integer has exactly one-third of the number of zeros to the right of the final nonzero digit as the original perfect cube.

**Example:**

$$\sqrt[3]{1,000,000} = 100$$

### Cube Roots of Small Perfect Cubes

The cube root of a perfect cube decimal has exactly one-third of the number of decimal places as the original perfect cube.

**Example:**

$$\sqrt[3]{0.000027} = \sqrt[3]{\frac{27}{1,000,000}} = \frac{3}{100} = 0.03$$

## Inequalities & Absolute Values

### Absolute Value

If  $a \geq 0$ ,  $|a| = a$

If  $a < 0$ ,  $|a| = -a$

**Examples:**

→  $|50| = 50$

→  $|-50| = -(-50) = 50$

### Equations with One Absolute Value

When solving equations with absolute values, we need to solve the equation twice, first for the condition in which the expression between the absolute value bars is positive and second for the condition in which the expression is negative.

**Example:**

$$|2x + 4| = 12, x = ?$$

$$\Rightarrow 2x + 4 = 12$$

$$\Rightarrow 2x = 8 \rightarrow x = 4$$

and

$$\Rightarrow -(2x + 4) = 12$$

$$\Rightarrow -2x - 4 = 12$$

$$\Rightarrow -2x = 16 \rightarrow x = -8$$

### When Two Absolute Values Are Equal to Each Other

If two absolute values are equal, it must be true that the expressions within the absolute value bars are either equals or opposites.

**Example:**

$$|16x + 14| = |8x + 6| \quad x = ?$$

**Case 1: The quantities within the absolute values are equal:**

$$\Rightarrow 16x + 14 = 8x + 6$$

$$\Rightarrow 8x = -8 \rightarrow x = -1$$

**Case 2: The quantities within the absolute values are opposites:**

$$\Rightarrow 16x + 14 = -(8x + 6)$$

$$\Rightarrow 16x + 14 = -8x - 6$$

$$\Rightarrow 24x = -20 \rightarrow x = -\frac{5}{6}$$

### Adding Absolute Values

This is always true:  $|a + b| \leq |a| + |b|$

#### A Second Rule When Adding Absolute Values

When  $|a + b| = |a| + |b|$ , this means:

- One or both quantities are 0; *or*
- Both quantities (a and b) have the same sign.

### Subtracting Absolute Values

This is always true:  $|a - b| \geq |a| - |b|$

#### A Second Rule When Subtracting Values

When  $|a - b| = |a| - |b|$ , this means:

- The second quantity is 0; *or*
- Both quantities have the same sign and the absolute value of  $|a - b|$  is greater than or equal to the absolute value of  $|a| - |b|$ .

**Example:**

$$|5 - 0| = |5| - |0| \quad \text{and} \quad |5 - 4| = |5| - |4|$$

*but*

$$|0 - 5| \neq |0| - |5| \quad \text{and} \quad |4 - 5| \neq |4| - |5|$$

## Word Problems

### Basic Word Translations

**Translations to Memorize:**

ENGLISH	TRANSLATION
is	=
was	=
has been	=
more	+
years older	+
years younger	-
less	-
times	×
less than	-
fewer	-
as many	×
factor	×
of	×

### Price Per Item

$$\Rightarrow \text{Price per Item} = \frac{\text{Total Cost}}{\text{Number of Items}}$$

### The Profit Equation

→ Profit = Total Revenue – Total Cost

or

→ Profit = Total Revenue – [Total Fixed Costs + Total Variable Costs]

### Simple Interest

→ Simple Interest = Principal × Rate × Time

### Compound Interest

$$\Rightarrow A = P \left( 1 + \frac{r}{n} \right)^{nt}$$

A = amount of interest

P = principal

r = rate of interest

n = number of times per year interest is compounded

t = time in years

### Linear Growth Formula

$$F_n = kn + p$$

F<sub>n</sub> = final growth

p = initial value

n = n<sup>th</sup> growth period

k = constant increase during each period

### Consecutive Integers

Can be expressed as:

- x
- (x + 1)
- (x + 2)
- (x + 3)
- (x + 4)
- (x + n)

### Consecutive Even or Odd Integers

Can be expressed as:

- x
- (x + 2)
- (x + 4)
- (x + 6)
- (x + 8)
- (x + 2n)

### Consecutive Multiples of Integers

Consecutive multiples of 5 can be expressed as:

- x
- (x + 5)
- (x + 10)
- (x + 15)
- (x + 20)
- (x + 5n)

### Rate Problems

#### Rate-Time-Distance Formula

⇒ Distance = Rate × Time

$$\Rightarrow \text{Time} = \frac{\text{Distance}}{\text{Rate}}$$

$$\Rightarrow \text{Rate} = \frac{\text{Distance}}{\text{Time}}$$

#### Average Rate Formula

$$\Rightarrow \text{Average Rate} = \frac{\text{Total Distance}}{\text{Total Time}}$$

#### Converging/Diverging Rate Formula

$$\text{dist}_{\text{object 1}} + \text{dist}_{\text{object 2}} = \text{total dist}_{\text{objects 1 and 2}}$$

### Round-Trip Rate Formula

Distance<sub>1</sub> = Distance<sub>2</sub>

### Catch-Up Rate Formula

Distance<sub>1</sub> = Distance<sub>2</sub>

### Catch-Up and Pass Formula

$$\Rightarrow \text{Time} = \frac{\Delta \text{Distance}}{\Delta \text{Rate}}$$

### Work Problems

#### Rate-Time-Work Formula

⇒ (Rate × Time) = Work

$$\Rightarrow \text{Time} = \frac{\text{Work}}{\text{Rate}}$$

$$\Rightarrow \text{Rate} = \frac{\text{Work}}{\text{Time}}$$

### An Object's Work Rate

Jackie can paint 20 fences in 4 weeks

Her rate is:

$$\left( \frac{20 \text{ fences}}{4 \text{ weeks}} \right) = 5 \frac{\text{fences}}{\text{week}}$$

A machine can produce 15 cars in 1 month

Thus, its rate is:

$$\left( \frac{15 \text{ cars}}{1 \text{ month}} \right) = 15 \frac{\text{cars}}{\text{month}}$$

### Combined Worker Formula

$$\text{Work}_{\text{Object 1}} + \text{Work}_{\text{Object 2}} = \text{Work}_{\text{Total}}$$

### Ratios

#### 3 Ways to Express a Ratio

$$\frac{\text{cats}}{\text{dogs}} = \frac{4}{3}$$

→ cats : dogs = 4 : 3

→ cats to dogs = 4 to 3

#### What Constitutes a Useful Ratio

$$\Rightarrow \frac{\text{number of workers}}{\text{number of managers}} = \frac{4 + m}{m}$$

↑ This is **NOT** a ratio.

$$\Rightarrow \frac{\text{number of workers}}{\text{number of managers}} = \frac{5m}{m} = \frac{5}{1} = 5 : 1$$

↑ This **IS** a ratio.

#### Ratio of Part to Total

→ **part 1 = x**

→ **part 2 = 3x**

$$\frac{\text{Part 1}}{\text{Total}} = \frac{\text{Part 1}}{\text{Part 1} + \text{Part 2}} = \frac{x}{x + 3x} = \frac{x}{4x} = \frac{1}{4}$$

### Multipart Ratio and the LCM

**Example:**

- Ratio 1:  $x : y = 3 : 4$
- Ratio 2:  $x : z = 7 : 11$

To combine ratios find the least common multiple (LCM) of the given values of  $x$ , which is 21.

Thus the combined ratio is:

→  $x : y : z = 21 : 28 : 33$

### Percent Word Problems

#### Converting to a Percent

To convert a fraction, decimal, or an integer to a percent, multiply the decimal or integer by 100 and attach the percent sign.

**Example:**

$$\frac{7}{100} \rightarrow \frac{7}{100} \times 100 = 7 \rightarrow 7\%$$

#### Converting from a Percent

To convert a percent to a decimal, drop the percent sign and divide by 100.

**Example:**

$$5\% = \frac{5}{100} = 0.05$$

### “Percent of” Translations

“Percent of” means to multiply a given percent by a given value.

**Examples:**

$$\Rightarrow 5 \text{ percent of } z \rightarrow \frac{5}{100} \times (z) = \frac{5z}{100} = \frac{z}{20}$$

$$\Rightarrow 36 \text{ percent of } k \rightarrow \frac{36}{100} \times (k) = \frac{9k}{25}$$

$$\Rightarrow 400 \text{ percent of } y \rightarrow \frac{400}{100} \times (y) = 4y$$

### “What Percent” Translation

**Example:**

→  $a$  is what percent of  $b$ ?

$$\Rightarrow \frac{a}{b} \times 100 = ?$$

### “Percent Less Than” Translations

$$\text{Final} = \left(1 - \frac{\% \text{ Less Than}}{100}\right) \times (\text{Initial})$$

**Examples:**

- $x$  is 2% less than  $y$
- $x = 0.98y$
- $x$  is 60% less than  $y$
- $x = 0.4y$

### “Percent Greater Than” Translations

$$\text{Final} = \left(1 + \frac{\% \text{ Greater Than}}{100}\right) \times (\text{Initial})$$

**Examples:**

- $x$  is 2% greater than  $y$
- $x = 1.02y$
- $x$  is 60% greater than  $y$
- $x = 1.6y$

### Variable Percent Translations

→  $1x$  is  $n$  percent of  $y$

$$\Rightarrow x = \frac{n}{100} \times y$$

→  $x$  is  $n$  percent less than  $y$

$$\Rightarrow x = \left(1 - \frac{n}{100}\right) \times y$$

$$\Rightarrow x = \left(\frac{100 - n}{100}\right) \times y$$

→  $x$  is  $n$  percent greater than  $y$

$$\Rightarrow x = \left(1 + \frac{n}{100}\right) \times y$$

$$\Rightarrow x = \left(\frac{100 + n}{100}\right) \times y$$

### “Percent Change” Formula

$$\left(\frac{\text{Final Value} - \text{Initial Value}}{\text{Initial Value}}\right) \times 100$$

### Statistics

#### Average (Arithmetic Mean)

$$\Rightarrow \text{average} = \frac{\text{sum of terms}}{\text{number of terms}}$$

#### Evenly Spaced Sets

**Examples:**

A set of **consecutive** integers:  
→ {4, 5, 6, 7, 8, 9, 10, 11, 12}

A set of consecutive **odd** integers:  
→ {3, 5, 7, 9, 11, 13, 15}

A set of consecutive **even** integers:  
→ {0, 2, 4, 6, 8, 10, 12}

A set of consecutive **multiples of 5**:  
→ {5, 10, 15, 20, 25, 30, 35}

A set of consecutive **multiples of 12**:  
→ {12, 24, 36, 48, 60, 72, 84}

#### Counting the Number of Integers in a Set of Consecutive integers (inclusive)

Highest Number – Lowest Number + 1

Counting the Number of Multiples of an Integer in a Set of Consecutive Integers (inclusive)

$$\Rightarrow \left( \frac{\text{Highest multiple} - \text{Lowest multiple}}{\text{Given Number}} \right) + 1$$

Average (Arithmetic Mean) in a Set of Consecutive Integers

$$\Rightarrow \frac{\text{Highest Number} + \text{Lowest Number}}{2}$$

Weighted Average Equation

Where dp = data point:

$$\frac{(dp\ 1) \times (\text{freq of } dp\ 1) + \dots + (dp\ n) \times (\text{freq of } dp\ n)}{\text{total freq of } dp\text{'s}}$$

Boundaries of a Weighted Average

The weighted average of two different data points will be closer to the data point with the greater number of observations or with the greater weighted percentage.

Median

When a set is numerically ordered, the median is the value in the middle of the arranged set.

Calculating Median with an Odd # of Terms

Where n is the number of terms in the set:

$$\text{Median} = \frac{(n + 1)}{2} \text{ position}$$

Calculating Median with an Even # of Terms

Where n is the number of terms in the set:

$$\text{Median} = \text{average of the values at the } \frac{n}{2}$$

and  $\frac{(n + 2)}{2}$  positions

Mean = Median

In any evenly spaced set, the mean of the set is equal to the median of the set.

Mode

The mode is the number that appears most frequently in a data set.

Range

= Highest Number in a Set – Lowest Number in a Set

Standard Deviation Range

- **High Value** = mean + x(sd)
- **Low Value** = mean – x(sd)

Two Important Standard Deviation Rules

**Adding / Subtracting a constant to each term in a set of numbers**

→ The standard deviation does not change.

**Multiplying / Dividing each term in a set of numbers by a constant**

→ The standard deviation will also be multiplied or divided by that amount.

### Overlapping Sets

Number of Members in Either Set

$$\#(A \text{ or } B) = \#(A) + \#(B) - \#(A \text{ and } B)$$

**Example:**

How many students play football or soccer? To solve:

$$\Rightarrow \text{Total \# football} + \text{Total \# soccer} - \# \text{ Both Football and Soccer}$$

Three Circle Venn Diagram Equations

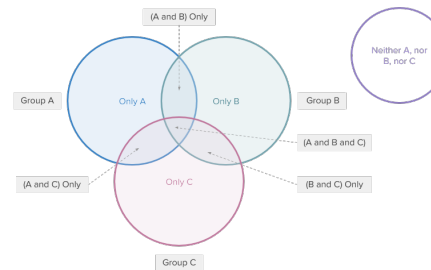

**When the Number of Unique Items Is Known**

$$\Rightarrow \text{Total \# of Unique Members} = \# [A \text{ Only} + B \text{ Only} + C \text{ Only}] + \#[(A \text{ and } B) \text{ Only}] + \#[(A \text{ and } C) \text{ Only}] + \#[(B \text{ and } C) \text{ Only}] + \#[(A \text{ and } B \text{ and } C)] + \#[\text{Neither A nor B nor C}]$$

**When the Number of Unique Items Is Unknown**

$$\Rightarrow \text{Total \# of Unique Elements} = \# \text{ in (Group A)} + \# \text{ in (Group B)} + \# \text{ in (Group C)} - \# \text{ in (Groups of Exactly Two)} - 2[\# \text{ in (Group of Exactly Three)}] + \# \text{ in (Neither)}$$

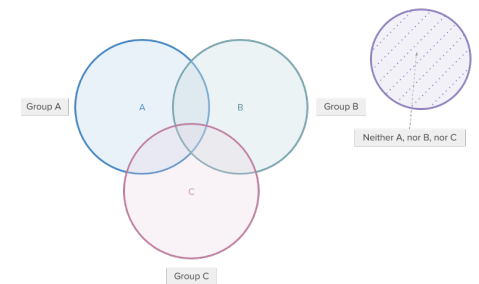
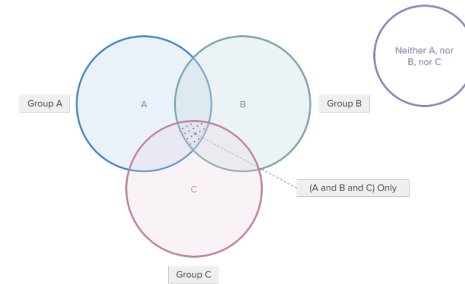
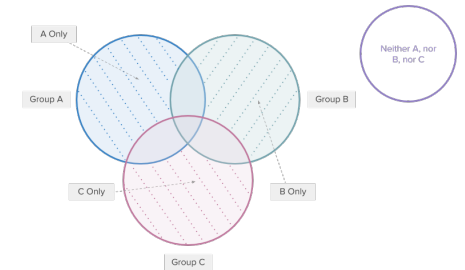

**Combinations & Permutations**

**Combinations**

Order does **NOT** matter

**The Basic Combination Formula**

$$\Rightarrow {}_n C_k = \frac{n!}{(n-k)!k!}$$

n = number of objects in the set  
k = number of objects selected

**Permutations**

Order **DOES** matter.

**The Basic Permutation Formula**

$$\Rightarrow {}_n P_k = \frac{n!}{(n-k)!}$$

n = number of objects in the set  
k = number of objects selected

**The Permutation Formula for Indistinguishable Items**

$$\Rightarrow P = \frac{N!}{(r_1!) \times (r_2!) \times (r_3!) \times \dots \times (r_n!)}$$

N = the total number of objects to be arranged.

r = the frequency of each indistinguishable object

**Example:**

What is the number of ways in which the letters A, A, B, B can be arranged?

$$\Rightarrow P = \frac{4!}{2! \times 2!} = \frac{4 \times 3 \times 2!}{2! \times 2!} = 6 \text{ ways}$$

**Circular Arrangements**

Number of ways to arrange a set of items in a circle

$$\rightarrow = (k - 1)!$$

k = number of objects to be arranged in the circle

**Probability**

**The Basic Probability Formula**

$$\Rightarrow \text{Probability} = \frac{\text{favorable \# of outcomes}}{\text{total \# of outcomes}}$$

**The Probability of a Sample Space**

**Must** sum to 1.

**Complementary Events**

$$\rightarrow P(A) + P(\text{Not } A) = 1$$

**The Probability of A and B**

**If A and B are independent:**

$$\rightarrow P(A \text{ and } B) = P(A) \times P(B)$$

**If A and B are not independent:**

$$\rightarrow P(A \text{ and } B) = P(A) \times P(B | A)$$

**The Addition Rule**

**Mutually Exclusive Events**

$$\rightarrow P(A \text{ or } B) = P(A) + P(B)$$

**Events That Are Not Mutually Exclusive**

$$\rightarrow P(A \text{ or } B) = P(A) + P(B) - P(A \text{ and } B)$$

**Probability of "Choosing At Least 1 Object"**

**P(at least 1 item occurs)**

$$\rightarrow = 1 - P(\text{none of these items occur})$$

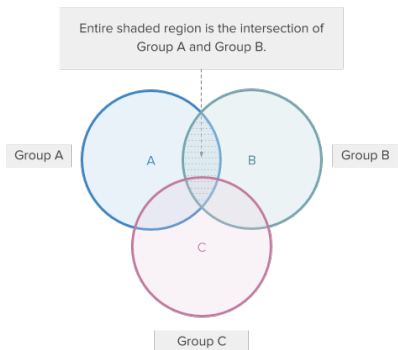
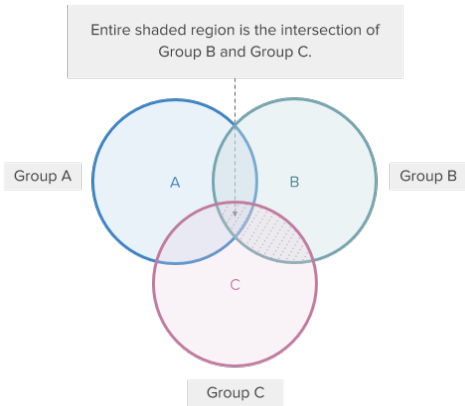

Geometry

Angles

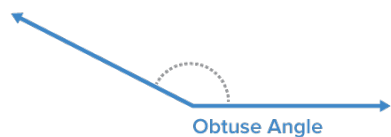
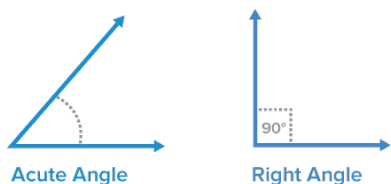

Supplementary Angles

Angles are supplementary if their measures sum to 180°.

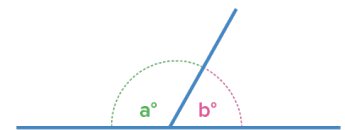

Angles a and b are supplementary

$a + b = 180^\circ$

Exterior Angle of a Triangle

An exterior angle of a triangle is equal to the sum of its two remote interior angles.

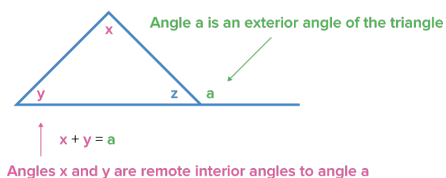

Parallel Lines Intersected by a Transversal

Vertical angles are equal  
 $a = d = e = h$  and  $b = c = f = g$

Corresponding angles are equal  
 $a = e, c = g, b = f, d = h$

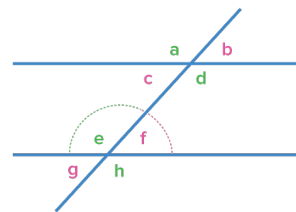

Any acute angle + any obtuse angle will sum to 180°

Supplementary angles sum to 180°

Area of a Triangle

$$\text{area} = \frac{\text{base} \times \text{height}}{2} = \frac{1}{2}bh$$

Triangle Inequality Theorem

In any triangle, the sum of the lengths of any two sides of the triangle is greater than the length of the third side.

Pythagorean Theorem

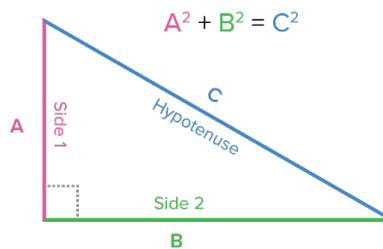

Pythagorean Triples

- 3-4-5 Right Triangle
- 5-12-13 Right Triangle

Isosceles Right Triangle

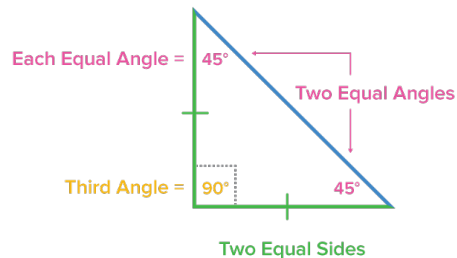

The Ratio of the Sides of a 45-45-90 Right Triangle

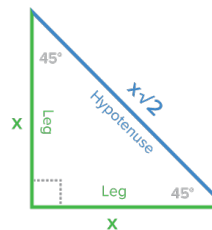

The Hypotenuse of a 45-45-90 Right Triangle is the Diagonal of a Square

A square's diagonal cuts the square into two 45-45-90 right triangles.

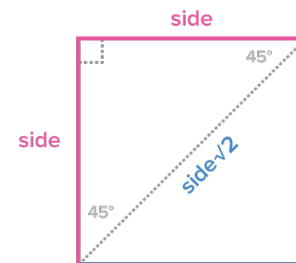

The Ratio of the Sides of a 30-60-90 Right Triangle

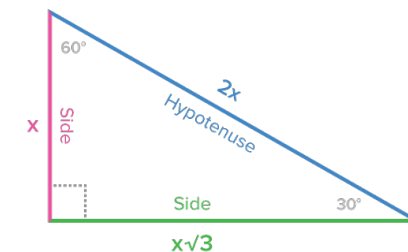

The Area of an Equilateral Triangle

$$\text{Area} = \frac{\text{side}^2 \sqrt{3}}{4}$$

Cutting an Equilateral Triangle in Half

Dropping an altitude from the upper vertex to the base of an equilateral triangle produces two identical 30-60-90 triangles.

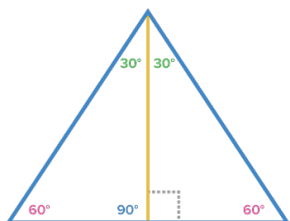

The Parallelogram

- Opposite sides are equal
- Opposite angles are equal

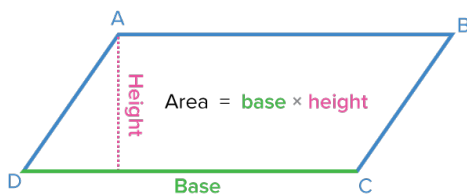

Rectangle

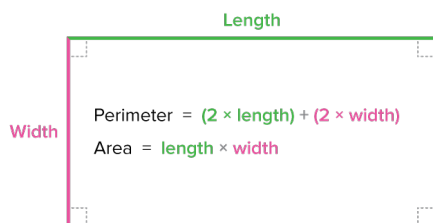

The Longest Line Segment of a Rectangle

The longest segment is the diagonal.

$$\text{Diagonal} = \sqrt{L^2 + W^2}$$

The Square

$$\text{Perimeter} = 4 \times \text{side}$$

$$\text{Area} = \text{side}^2$$

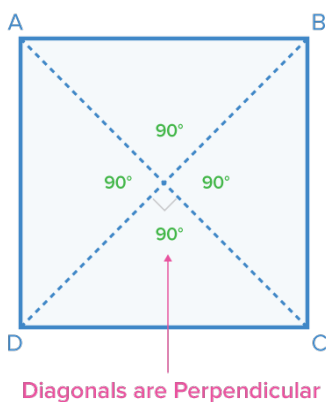

The Maximum Area of a Rectangle

Given a rectangle with a fixed perimeter, the rectangle with the maximum area is a square.

The Minimum Perimeter of a Rectangle

Given a rectangle with a fixed area, the rectangle with the minimum perimeter is a square.

The Trapezoid

$$\text{Area} = \frac{(\text{base}_1 + \text{base}_2) \times \text{height}}{2}$$

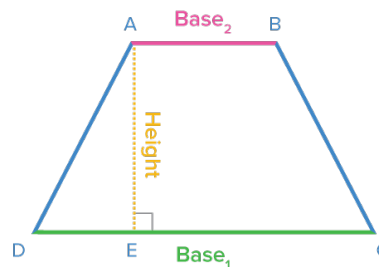

Interior Angles of a Polygon

The sum of the interior angles of a polygon =  $(n - 2) \times 180$ , where n = the number of sides in the polygon.

Hexagons

$$\text{Area} = \frac{3\sqrt{3}}{2} s^2$$

Exterior Angles of Any Polygon

They always sum to 360°.

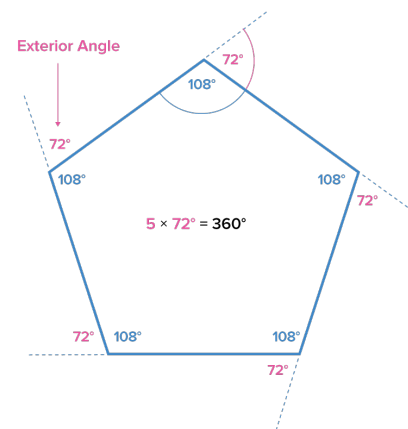

Circles

Where r = radius: Area =  $\pi r^2$   
Circumference =  $2\pi r$

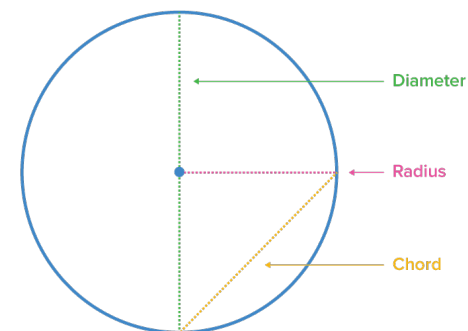

Arc Length and Sector Area

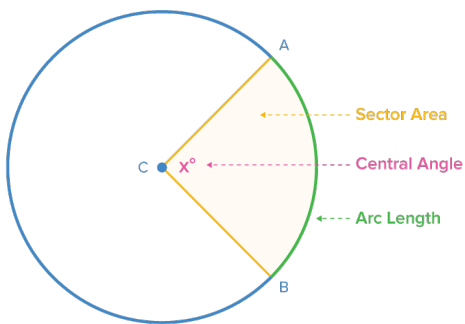

**Arc Length**  

$$\frac{\text{central angle}}{360} = \frac{\text{arc length}}{\text{circumference}}$$

**Sector Area**  

$$\frac{\text{central angle}}{360} = \frac{\text{area of sector}}{\text{area of circle}}$$

Inscribed Angles in Circles

Angles AOC and ABC share the same endpoints, Points A and C

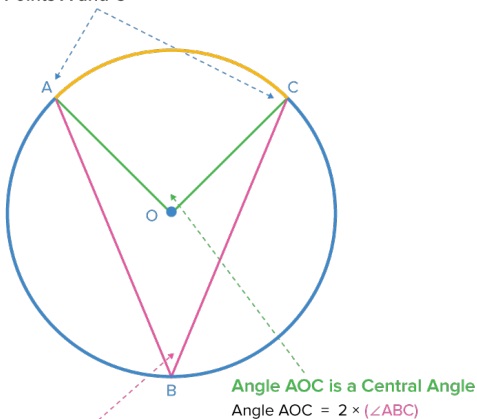

Angle ABC is an Inscribed Angle  
 Angle ABC = 1/2 the degree measure of arc AC

Right Triangle Incribed in a Circle

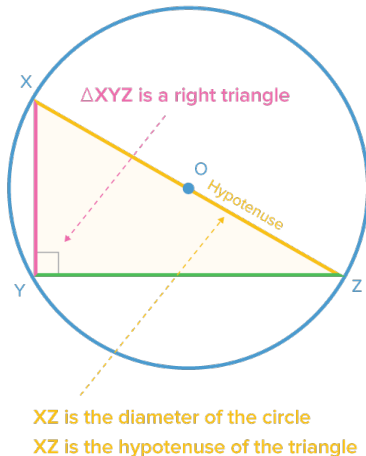

Regular Polygons Incribed In Circles

When a regular polygon is inscribed in a circle, the polygon divides the circle into arcs of equal length.

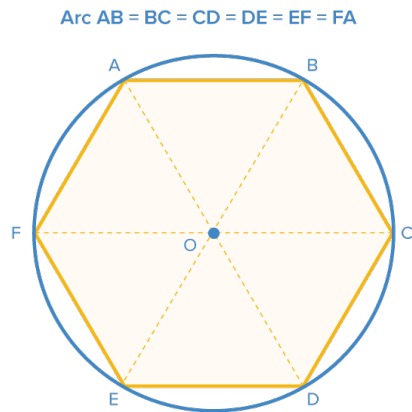

The Area of a Circular Ring

Where :  
 $R_1$  = radius of the inner circle and  
 $R_2$  = radius of the entire 2-circle system

Area of Outer Ring =  $\pi(R_2^2 - R_1^2)$

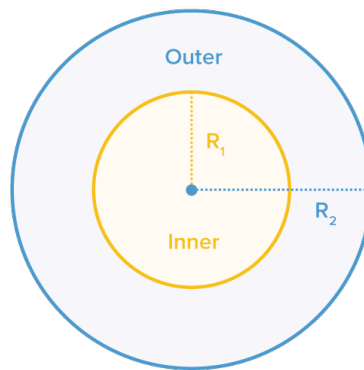

The Cylinder

Where r = radius and h = height:

Surface Area =  $2(\pi r^2) + 2(\pi rh)$

Volume =  $\pi r^2 h$

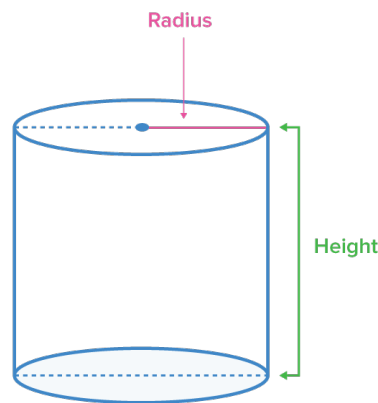

The Cube

Surface Area =  $6 \times \text{side}^2$

Volume =  $\text{side}^3$

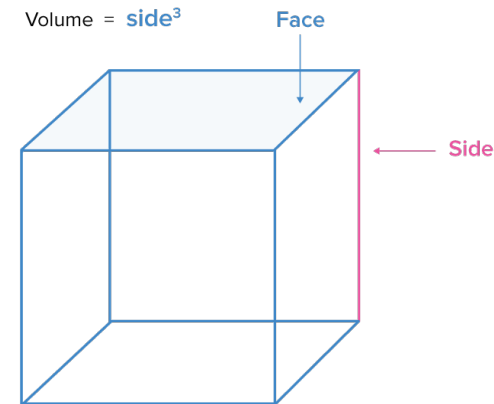

The Rectangular Solid

Where :

H = Height, L = Length, W = Width

Surface Area =  $2(W \times L) + 2(W \times H) + 2(L \times H)$

Volume =  $L \times W \times H$

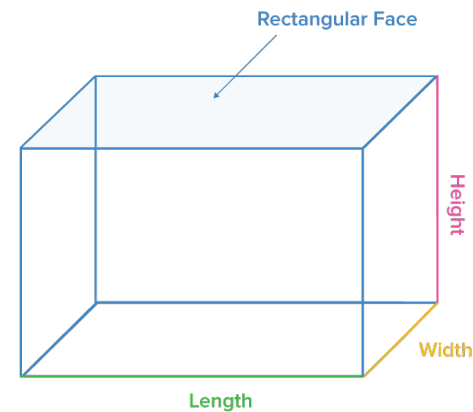

The Diagonal of a Rectangular Solid or Cube

**Cube**

Diagonal = side $\sqrt{3}$

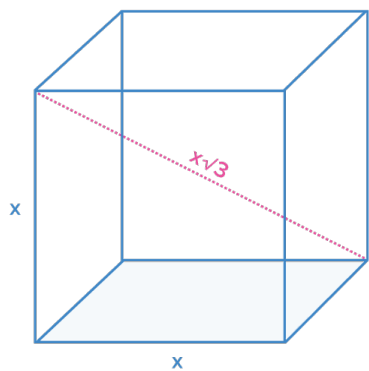

**Rectangular Solid**

Diagonal<sup>2</sup> = L<sup>2</sup> + W<sup>2</sup> + H<sup>2</sup>

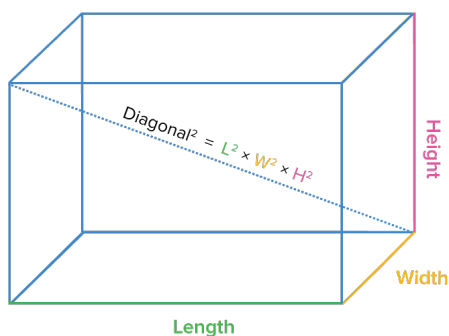

**Coordinate Geometry**

The Coordinate Plane

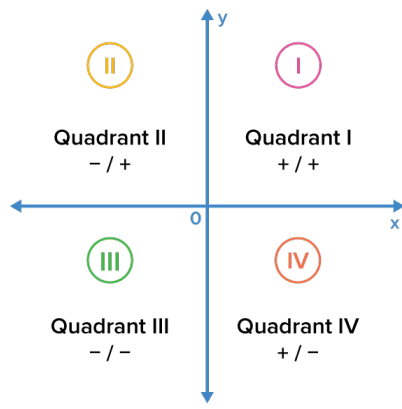

Slope of a Line

$\Rightarrow \text{slope} = m = \frac{\Delta y}{\Delta x} = \frac{y_2 - y_1}{x_2 - x_1} = \frac{\text{Rise}}{\text{Run}}$

where :

- y<sub>2</sub> = the second y-coordinate
- y<sub>1</sub> = the first y-coordinate
- x<sub>2</sub> = the second x-coordinate
- x<sub>1</sub> = the first x-coordinate
- m = slope of the line

The Slope-Intercept Equation

$\Rightarrow y = mx + b$

where :

- y = the y-coordinate
- x = the corresponding x-coordinate
- m = the slope of the line
- b = the y-intercept of the line

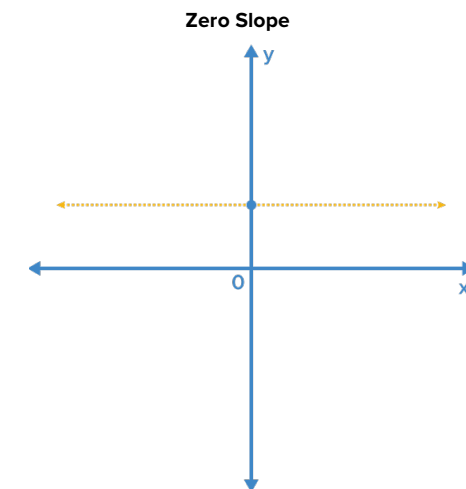
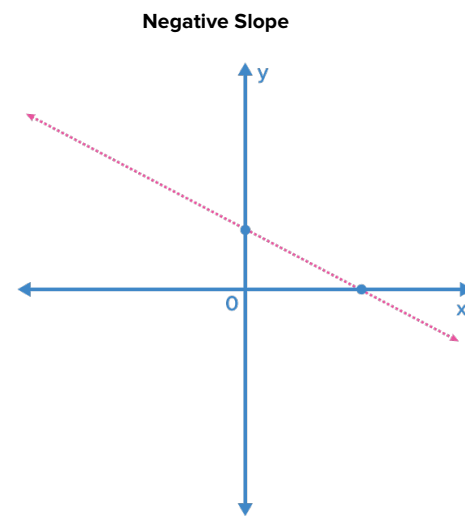
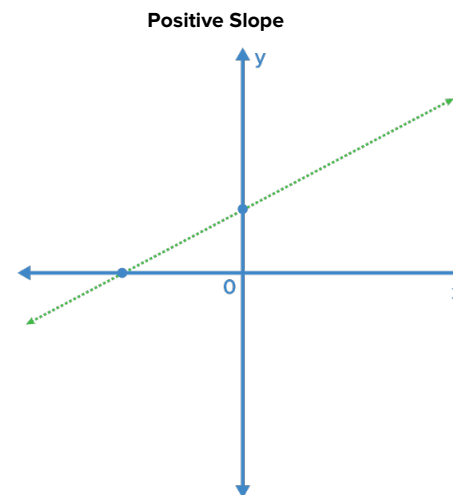

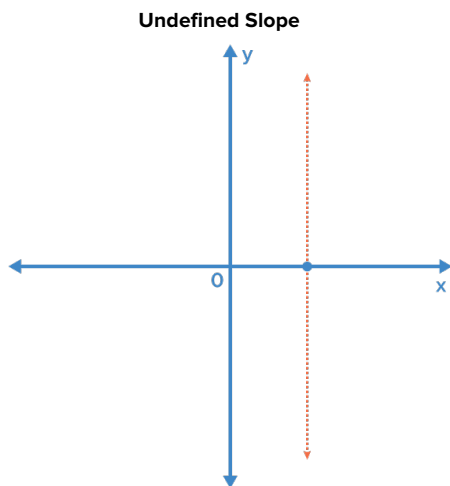

### Parallel Lines

Parallel lines have the same slope but different y-intercepts, and as a result, the lines will never intersect.

### Perpendicular Lines

The slopes of two perpendicular lines are negative reciprocals; negative reciprocals multiply to -1.

### Reflections

#### Reflection over the x-axis

$$(x, y) \rightarrow (x, -y)$$

#### Reflection over the y-axis

$$(x, y) \rightarrow (-x, y)$$

#### Reflection over the origin

$$(x, y) \rightarrow (-x, -y)$$

### The Distance Formula

$$\text{Distance} = \sqrt{(x_2 - x_1)^2 + (y_2 - y_1)^2}$$

### Midpoint Formula

$$\text{Midpoint} = \left( \frac{x_1 + x_2}{2}, \frac{y_1 + y_2}{2} \right)$$

## Functions and Sequences

### Range

The set of all the numbers a function can generate (i.e., the set of all outputs) is called the range of the function.

### Domain

The set of all the numbers that a function can use (i.e., the set of all inputs) is called the domain of the function.

### Arithmetic Sequences

An arithmetic sequence is a sequence in which the difference between every pair of consecutive terms is the same.

#### Formula:

$$a_n = a_1 + (n - 1)d$$

Where  $a_n$  is the  $n^{\text{th}}$  term in the sequence,  $a_1$  is the first term of the sequence, and  $d$  is the common difference

#### Example:

$$\begin{aligned} \rightarrow & 5, 10, 15, 20 \\ \rightarrow & 20 = 5 + (4 - 1)5 \\ \rightarrow & 20 = 20 \end{aligned}$$

### Sum of the Terms of an Arithmetic Sequence

$$S_n = \frac{n}{2}(a_1 + a_n)$$

$$S_n = \frac{4}{2}(5 + 20)$$

$$S_n = 2(25)$$

$$5 + 10 + 15 + 20 = 50$$

### Geometric Sequence

A geometric sequence (or geometric progression) is one in which the *ratio* between every pair of consecutive terms is the same.

#### Formula:

$$a_n = a_1 \times r^{n-1}$$

Where  $a_n$  is the  $n^{\text{th}}$  term and  $a_1$  is the first term of the sequence, and  $r$  is the common ratio.

#### Example:

$$\begin{aligned} \rightarrow & 5, 10, 20, 40 \\ \rightarrow & 40 = 5 \times 2^{4-1} \\ \rightarrow & 40 = 40 \end{aligned}$$